

TECHNICAL DATA

FOZMULA
INNOVATION IN SENSORS

S100 series temperature switches



The **S100 Series** of temperature switches comprises a wide range of switches each designed to meet a customer specific application. They are available in a selection of body styles, connector configurations, switching temperatures and senses, i.e. normally open, normally closed or changeover.

This range of products has been designed and engineered to be rugged and durable, and capable of extensive service in demanding environments. Suitable for use on many types of industrial engines, the **S100 Series** can withstand significant levels of vibration, shock, temperature and humidity.

SPECIFICATION

Threads:

Standard thread sizes are 3/8"NPTF, 1/2"NPTF, 5/8"UNF, M14 or M18
Other thread sizes are also available.

Temperature ranges:

Standard N/O configuration (other ranges and switching senses are available upon request):

- 40 - 30°C
- 50 - 40°C
- 90 - 80°C
- 100 - 90°C
- 105 - 95°C

Environmental:

Service temperature: -40°C to +140°C
Vibration: 15.3 grms (3 orthogonal planes for 3 hours per plane) to BSEN 60068-2-64 : 1993

Construction

Body: Brass to CZ121/131
Connector: 30% PBT
Terminals: Brass CZ108 silver or nickel plated.

Electrical:

Switching current: 1 Amp max
Switching cycles: Min 100,000 operations

Connector types, please enquire for other designs

Typical body arrangements – please enquire for other sizes

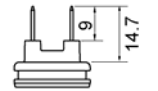
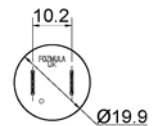
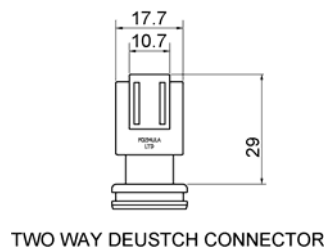
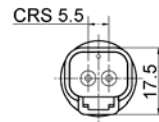
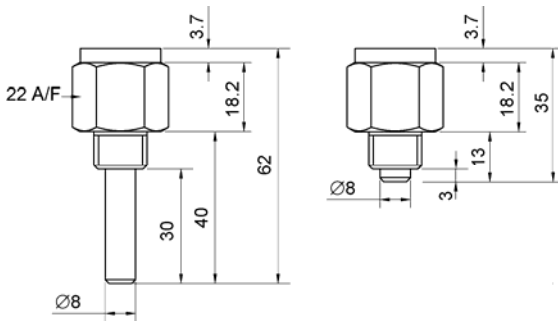

TWIN 6.35MM SPADES TOP Moulding Connector

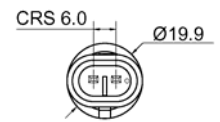
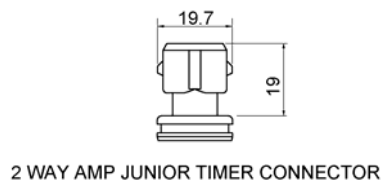
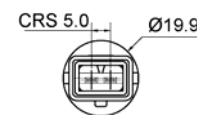

2 WAY PACKARD METRI-PACK 150 SERIES CONNECTOR.

Berrington Road | Leamington Spa | Warwickshire CV31 1NB | UK

Tel: +44 (0)1926 466700 | Fax: +44 (0)1926 450473 | www.fozmula.com

www.fozmula.com

E. & O. E. © Fozmula Limited. July 2008 Issue No. 1

Since the suitability of these products depends upon a wide range of factors not in our control, Fozmula Limited expects and understands that you will conduct the testing and evaluation necessary to determine that these products are suitable for your application. Whilst every effort is made to ensure the above details are correct at the time of printing, Fozmula Limited reserves the right to make material changes, and or technical changes without notification.